

OMNI-493

ANTENNAS | OMNI-493 SERIES

OMNI-DIRECTIONAL, MARINE & COASTAL LTE/5G ANTENNA

617 – 3800 MHz, 9 dBi

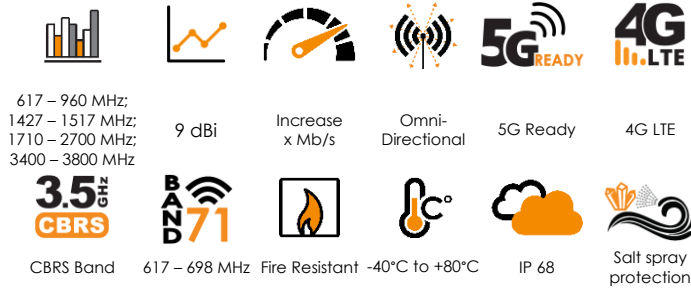

- **High performance, ultra-wideband omni-directional antenna**
- **Easy mounting with feed through 1-inch standard marine adapter bracket included**
- **Robust and can withstand adverse weather conditions at sea (IP68)**
- **Various 316 stainless steel mounting brackets available optionally**
- **UV and saltwater protected against tempestuous weather conditions**



APPLICATION AREAS

Product Overview

The OMNI-493 is an ultra-wideband, high performance, omni-directional antenna that covers the contemporary 4G/LTE and future 5G operating frequencies with excellent balanced gain across all frequencies. The ultra-wideband performance from the antenna allows it to operate from 617 to 3800 MHz, with a peak gain of 9 dBi. The antenna is future proof as it covers the up-and-coming LTE Band 71 (617 to 698 MHz band), as well as 3400 to 3800 MHz CBRS band which will be utilized for future 5G applications. This makes the antenna usable in all parts of the world and guarantees signal reception almost everywhere. The antenna design allows for superior pattern control over the entire frequency range, making the OMNI-493 a true high performance omni-directional antenna, suitable for marine and coastal applications. The exceptional wideband performance is an important factor for LTE and future 5G technologies, where these technologies rely on features such as Carrier Aggregation (CA) to provide the best possible reception and throughput over multiple frequency bands simultaneously.

Features

- High gain omni-directional antenna
- Includes band 71 (617 to 698 MHz) and 3.5 GHz 5G bands
- Wideband operation, makes the antenna future proof
- Antenna is purpose-built for marine and coastal operation
- Robust and weather resistant design with IP68 rating
- UV stable and saltwater resistant enclosure for marine

Application Areas

- Marine applications / Yachts / Boats / Ferries
- Enhanced 4G/LTE and 5G reception
- IoT & M2M applications
- Areas with poor data signal reception
- Improve data transmission connection reliability & stability



Frequency Bands

The OMNI-493 is an omni-directional antenna that works from 617 – 960 MHz | 1427 – 1517 MHz | 1710 – 2700 MHz | 3400 – 3800 MHz

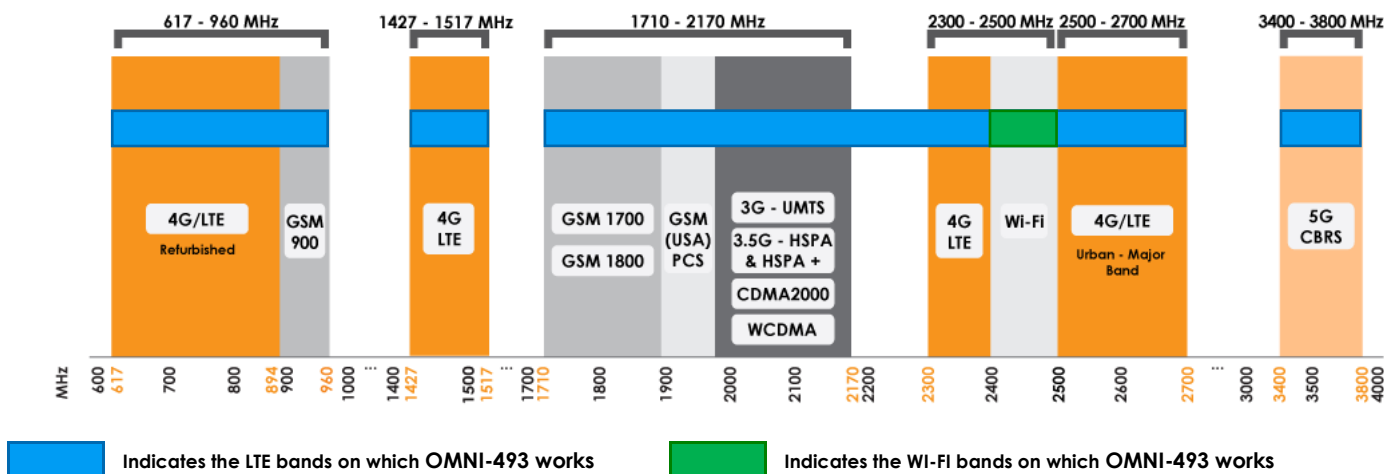

Antenna Overview

Ports	1
SISO / MIMO	SISO
Frequency Bands	617 – 3800 MHz
Polarisation	Linear Vertical
Peak Gain	9 dBi
Coax Cable Type	N/A
Coax Cable Length	N/A
Connector Type	N-Type (F)

*The connector is factory mounted to the antenna

Electrical Specifications

Frequency bands:	617 – 960 MHz 1427 – 1517 MHz 1710 – 2700 MHz 3400 – 3800 MHz
Gain (max):	6 dBi @ 617 - 960 MHz 6 dBi @ 1427 - 1517 MHz 9 dBi @ 1710 – 2700 MHz 8 dBi @ 3400 -3800 MHz
VSWR:	<2.5:1 over 90% of the bands
Feed power handling:	10 W
Input impedance:	50 Ohm (nominal)
Polarisation:	Linear Vertical
DC short:	Yes

Product Box Contents

Antenna:	A-OMNI-0493
Mounting bracket:	1" (14 TPI) Marine Adapter (BRKT-40) & L-bracket (Ø30-50mm Pole)

Ordering Information

Commercial name:	OMNI-493
Order product code:	A-OMNI-0493-V1-01
EAN number:	6009710922262

Mechanical Specifications

Product dimensions	646 mm x Ø75 mm (excl. BRKT-40)
Packaged dimensions:	704 mm x 147 mm x 100 mm
Radome material:	UV Stable Marine ASA
Radome colour:	Brilliant White Pantone P 179-1C
Mounting Type:	Standard 1" -14 TPI marine mount & Wall/pole mount

Environmental Specifications, Certification & Approvals

Wind Survival:	<160 km/h
Temperature Range (Operating):	-40°C to +80°C
Environmental Conditions:	Outdoor/Indoor
Water ingress protection ratio/standard:	IP 68
Salt Spray:	MIL-STD 810G/ASTM B117
Operating Relative Humidity:	Up to 98%
Storage Humidity:	5% to 95% - non-condensing
Storage Temperature:	-40°C to +70°C
Enclosure Flammability Rating:	UL 94-HB
Impact resistance:	IK 08
Product Safety & Environmental:	Complies with CE and RoHS standards



Antenna Performance Plots

VSWR

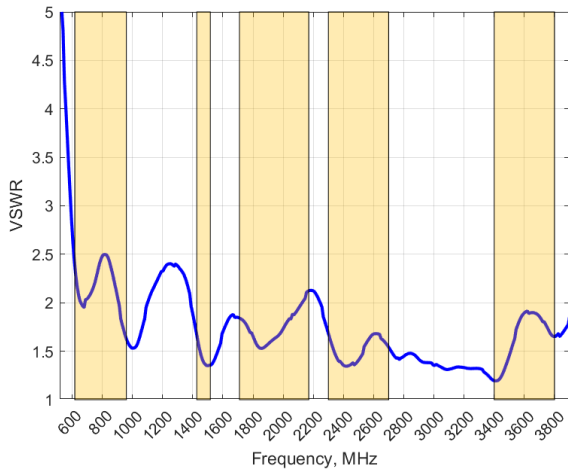

GAIN (EXCLUDING CABLE LOSS)

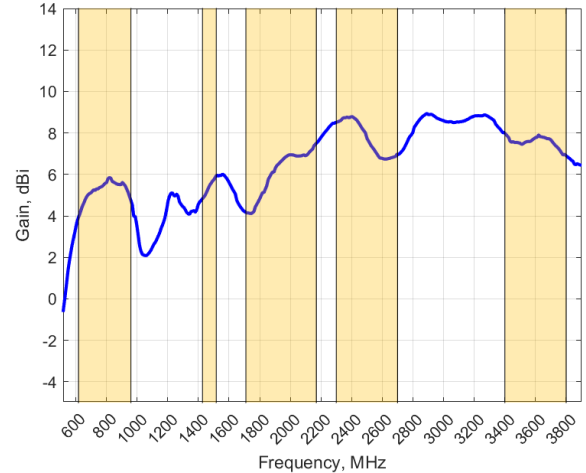

Voltage Standing Wave Ratio (VSWR)

VSWR is a measure of how efficiently radio-frequency power is transmitted from a power source, through a transmission line, into a load. In an ideal system, 100% of the energy is transmitted which corresponds to a VSWR of 1:1.

The OMNI-493 delivers superior performance across all bands with a VSWR of 2.5:1 or better over 90% of the bands.

**Antenna VSWR measured with no cable*

Gain* in dBi

9 dBi is the peak gain across all bands from 617 - 3800 MHz

Gain @ 617 – 960 MHz:	6 dBi
Gain @ 1427 – 1517 MHz:	6 dBi
Gain @ 1710 – 2700 MHz:	9 dBi
Gain @ 3400 – 3800 MHz :	8 dBi

**Antenna gain measured with polarisation aligned standard antenna*

Technical Drawings

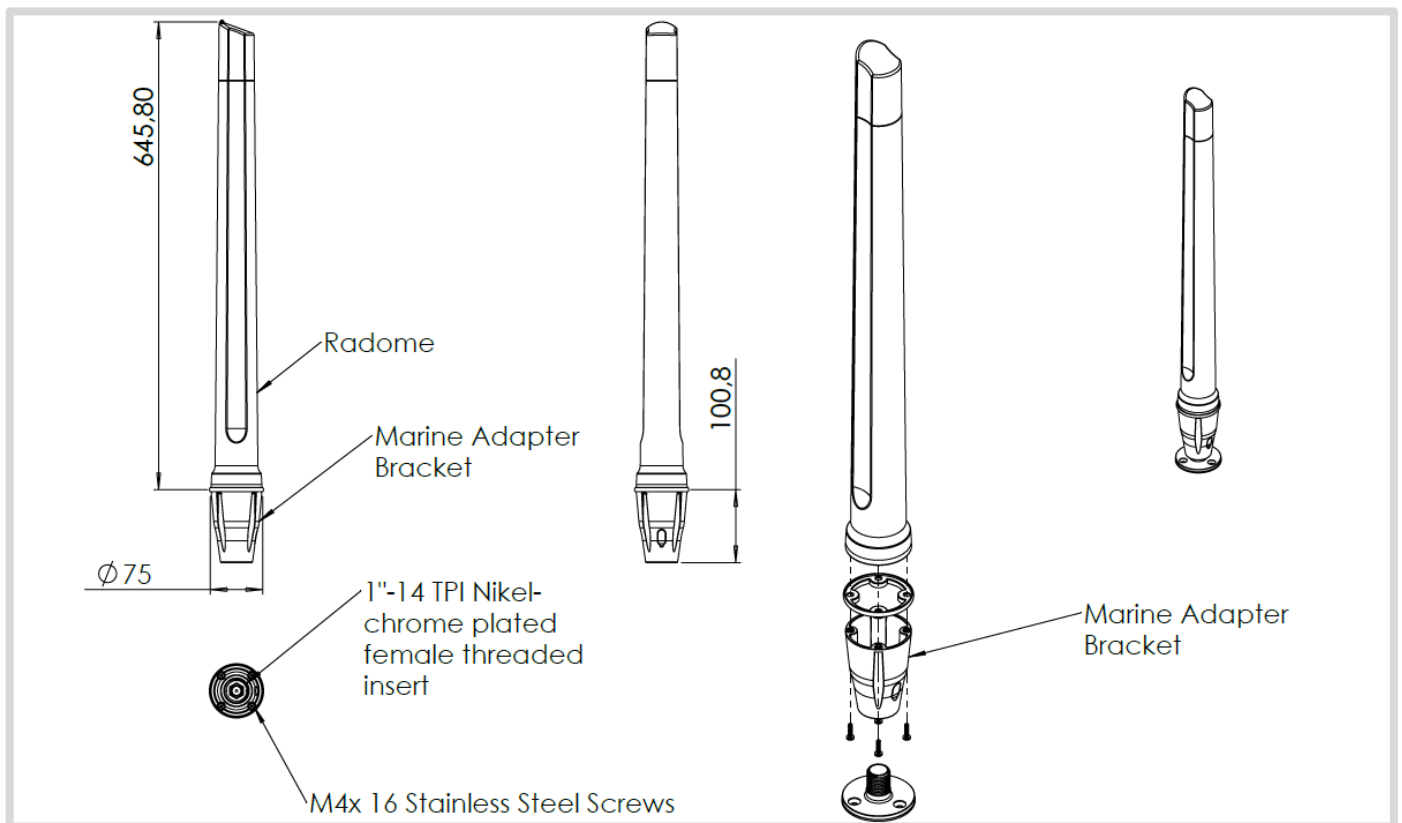

Radiation Patterns

Azimuth: 617 – 960 MHz Azimuth: 1427 – 1517 MHz

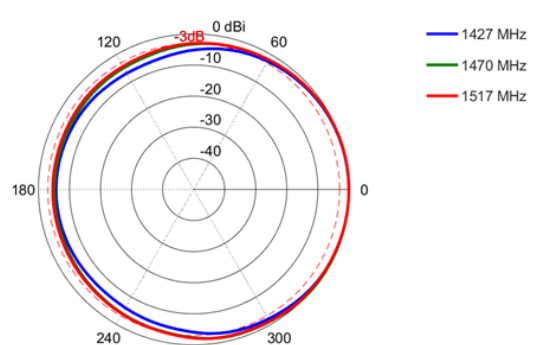
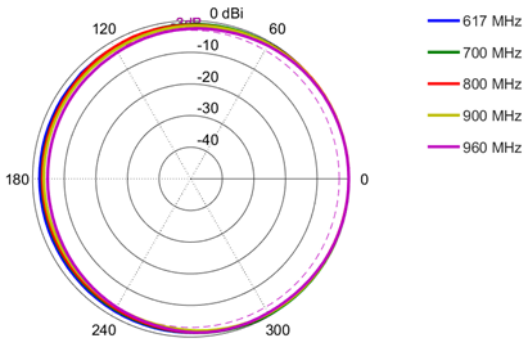

Azimuth: 1710 – 2170 MHz Azimuth: 2300 – 2700 MHz

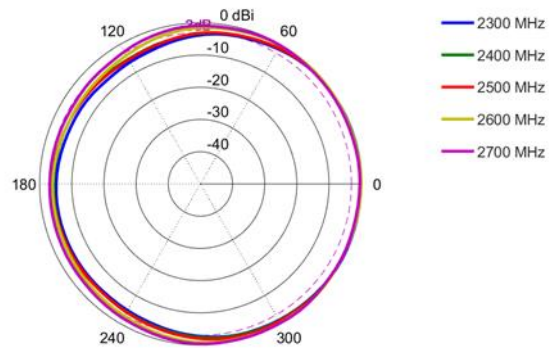
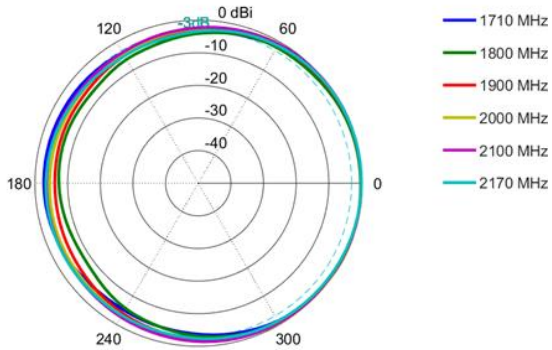

Azimuth: 3400 – 3800 MHz Elevation: 617 – 960 MHz

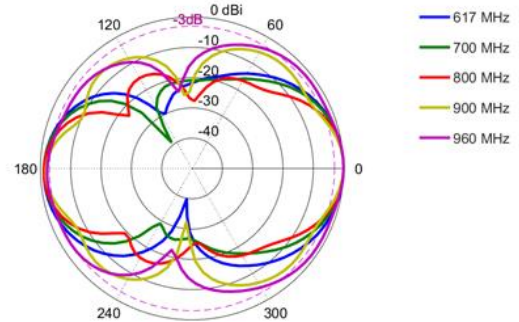
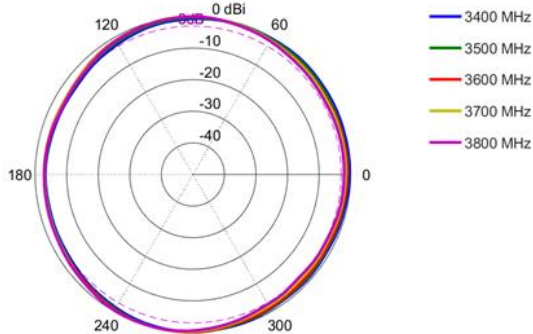

Elevation: 1427 – 1517 MHz Elevation: 1710 – 2170 MHz

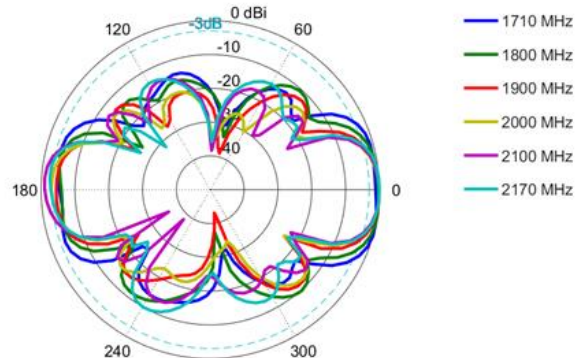
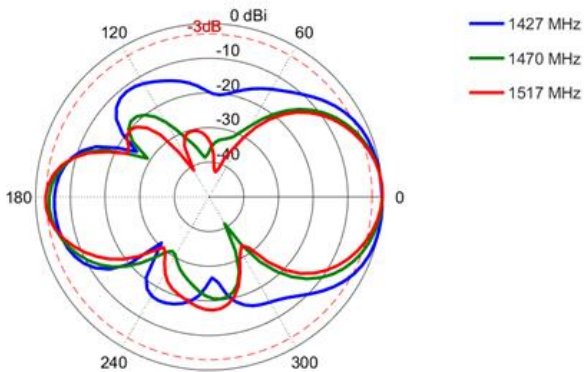

Elevation: 2300 – 2700 MHz | Elevation: 3400 – 3800 MHz

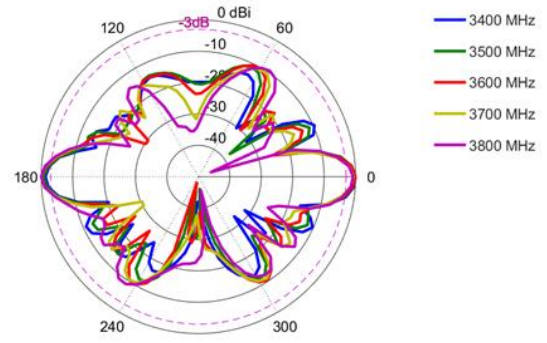
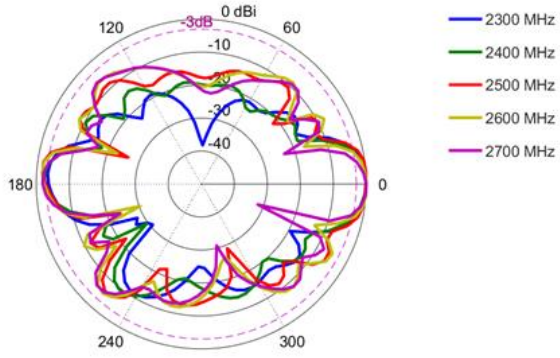

Mounting Options

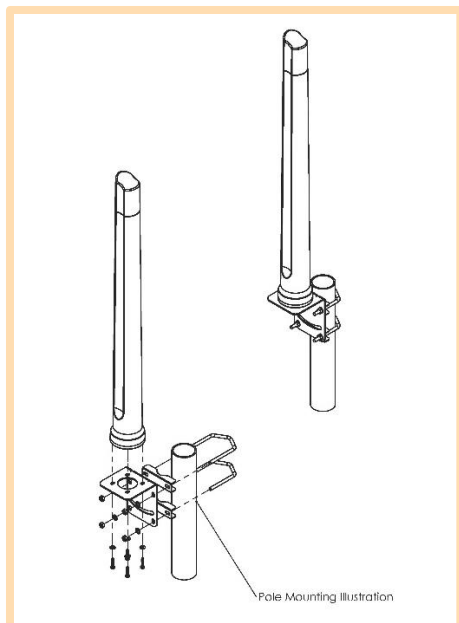

Pole Mount

L-Bracket 316 Stainless Steel – included
 (for Ø 30-50mm pole)

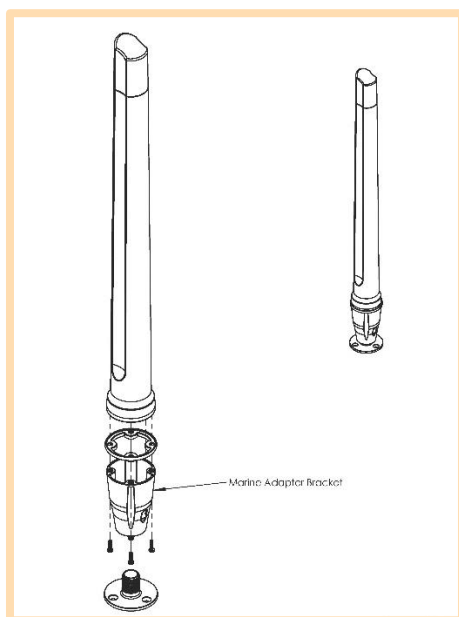

Marine Bracket Mount

1" -14 TPI female adapter – included

Mounts to standard marine brackets:

- BRKT-37: Flat Mount - Optional
- BRKT-38: Ratchet Mount - Optional
- BRKT-39: Rail Mount - Optional

See Optional Accessories below

Also available: BRKT-41 with 1.25" – 11TPI female adapter (Optional)

See Accessories below

Optional Accessories



BRKT-37

Marine flat mount antenna bracket 1"-14TPI 316 Stainless Steel



BRKT-38

Marine ratchet rail mount antenna bracket 1"-14TPI 316 Stainless Steel



BRKT-39

Heavy duty marine mount antenna bracket 1"-14TPI 316 Stainless Steel

See accessories technical specifications on www.poynting.tech

Contact Poynting

Poynting Antennas (Pty) Ltd - Head Office

Unit 4, N1 Industrial Park
Landmarks Avenue,
Samrand, 0157
South Africa

Phone: +27 (0) 12 657 0050

E-mail: sales@poynting.co.za

Poynting Europe

Regus Business Center Neue Messe Riem
Kronstadter Straße 4
81677 München
Germany

Phone: +49 89 208026538

E-mail: sales-europe@poynting.tech