

MARITIME ANTENNA

Maritime 40G

Overview

- **Designed for Maritime Applications**
IP68 rated, durable and UV-stable housing an omnidirectional antenna for the best signal reception.
- **Designed for 5G**
Optimal gain, 4x4 MIMO antenna configuration for the best performance for maritime installations.
- **Ultra-wide bandwidth**
Wide frequency range (410-6000MHz) for supporting LTE and 5G connectivity.
- **Easy installation**
Supports standard maritime 1" 14 TPI thread mount and also has an L-shape mount for non-standard installations.
- **Wi-Fi bands**
The antenna is designed for cellular bands but also covers both 2.4 & 5GHz Wi-Fi frequencies. To use the antennas for Wi-Fi, you will require an SMA to RP-SMA adapter.

Applications

- **Maritime**

7
dBi

IP
68

4x4
MIMO

↑↓
LTE

📍
GPS

Built
for
5G

Specification

Cellular

Antenna elements	4 elements
Cellular frequency bands & Gain	3.2dBi: 410-470MHz 3.8dBi: 617-960MHz 5.3dBi: 1710-2700MHz 6.5dBi: 3400-4200MHz 6.7dBi: 4900-6000MHz
VSWR	<3.5: 410-470MHz <3.0: 617-960MHz <2.5: 1710-6000MHz
Max feed power handling	10W
Input impedance	50 Ω
Polarisation	Linear

GPS

Frequency range	1561-1602 MHz
Peak gain	0.5dBi@1575MHz 1.6dBi@1602MHz
VSWR	< 2.5
Output return loss	10dB max
LNA gain	28 ±3dB
Noise figure	1.5dB max at 3.3V
Operating Voltage	3.3V
Power consumption	8.5mA ±2.5m at 3.3V

Cable (LTE/5G)

Type	CFD-200
Length	6'7" / 2m
Loss	0.33 dB/m @ 900 MHz 0.49 dB/m @ 2000 MHz 0.55 dB/m @ 2500 MHz 0.87 dB/m @ 5800 MHz
Diameter	13/64" / 5.0mm
Jacket	Half matt PVC, UV resistant
Termination	SMA male

Cable (GPS)

Type	RG-174
Length	6'7" / 2m
Loss	3.4 dB/m @ 1000 MHz 4.9 dB/m @ 1800 MHz
Diameter	0.1" / 2.7mm
Jacket	Half matt PVC, UV resistant
Termination	SMA male

Maritime 40G

Mounting

Supported types	Standard Maritime 1" 14 TPI thread Pole and wall mounting Pole diameter: 1-2" (25-50mm)
-----------------	---

Mechanical

Product dimensions	(Diameter) 3.78" / 96mm (Height) 34.39" / 873.5mm
Packaged dimensions	41.54" x 6.0" x 6.1" 1055 x 153 x 155mm
Housing material	UV stable PC

Package contents

Antenna	Maritime Antenna 40G
Accessories	Maritime mount set L-shape mount set Deck mount (ACW-652)

Environmental & Compliance

IP rating	IP68
Operating temperature	-40° - 176°F / -40° - 80°C
Storage temperature	-40° - 176°F / -40° - 80°C
Compliance	ROHS, REACH, WEEE
Wind survivability	100mph / 160km/h
Salt Spray	MIL-STD 810F/ASTM B117

Ordering Information

Product Code	ANT-MR-40G-S-W-6
Description	4x LTE/5G, 1x GPS 410-6000MHz, IP68, SMA male, White, 6.5 ft / 2m

Contact Us

maritime@peplink.com

Find a Peplink Certified Partner

<https://www.peplink.com/peplink-certified-partners/>

Technical Drawing

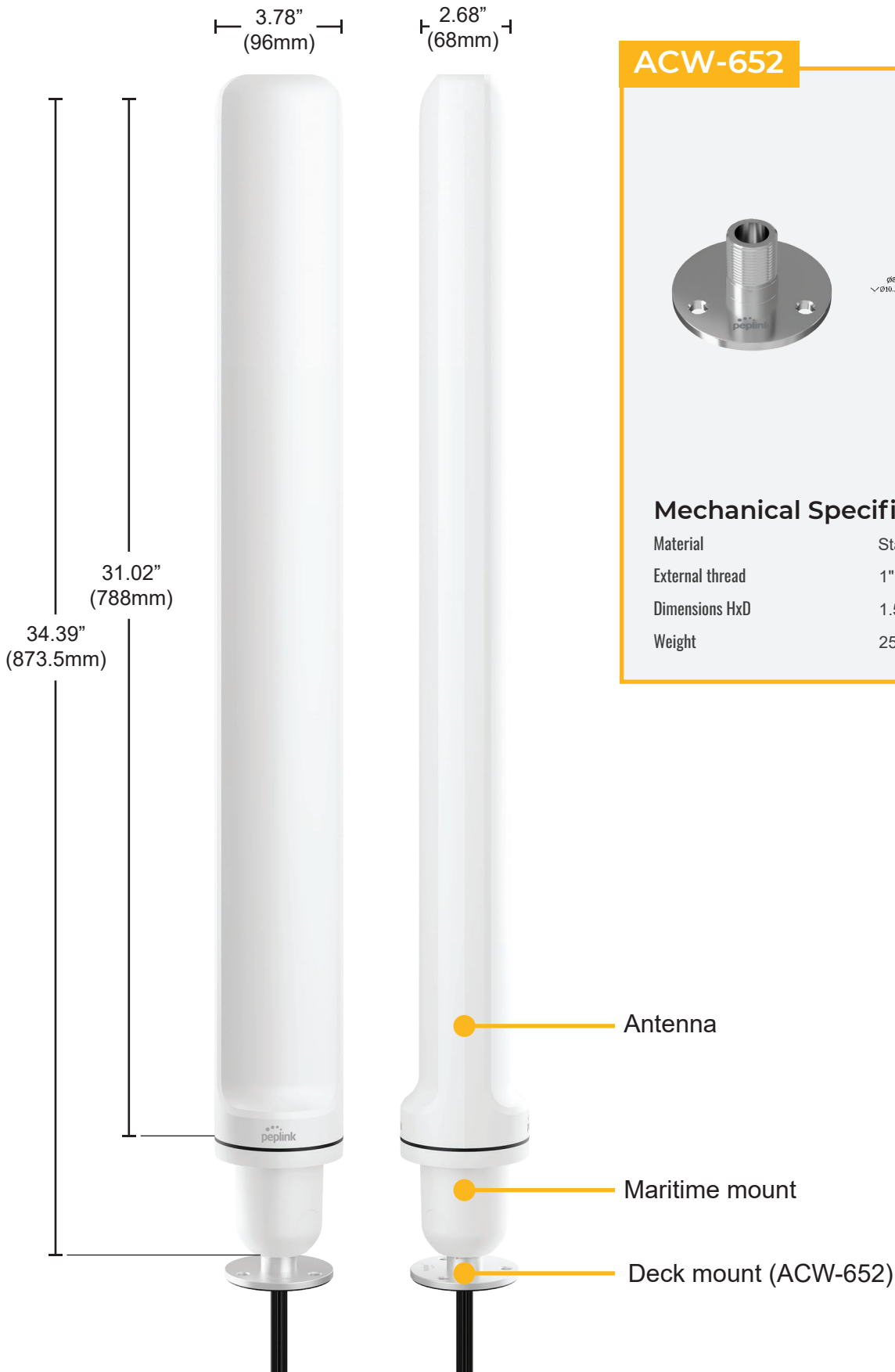

ACW-652

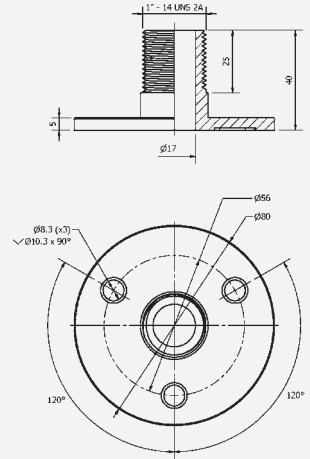

Mechanical Specification

Material	Stainless Steel SS316
External thread	1" 14 TPI
Dimensions HxD	1.57" x 3.15" (40 x 80mm)
Weight	250g / 0.55 pounds

Cellular Antenna VSWR

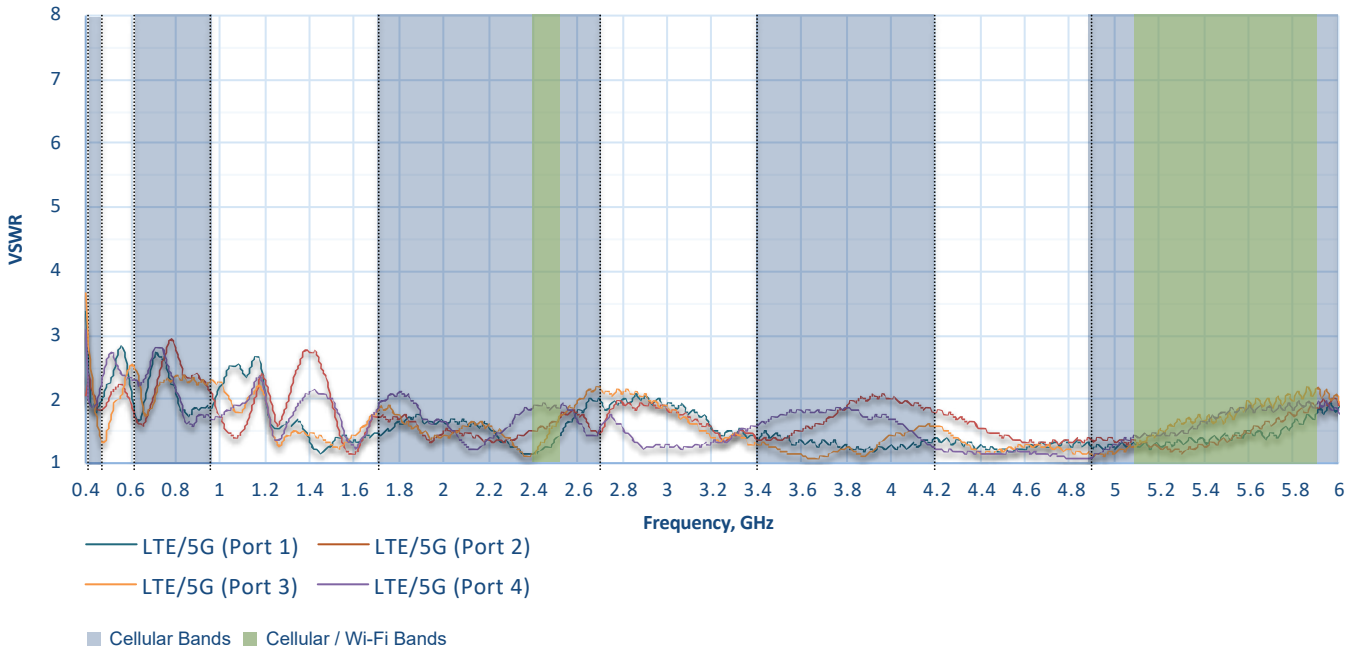

Cellular Antenna Element Isolation

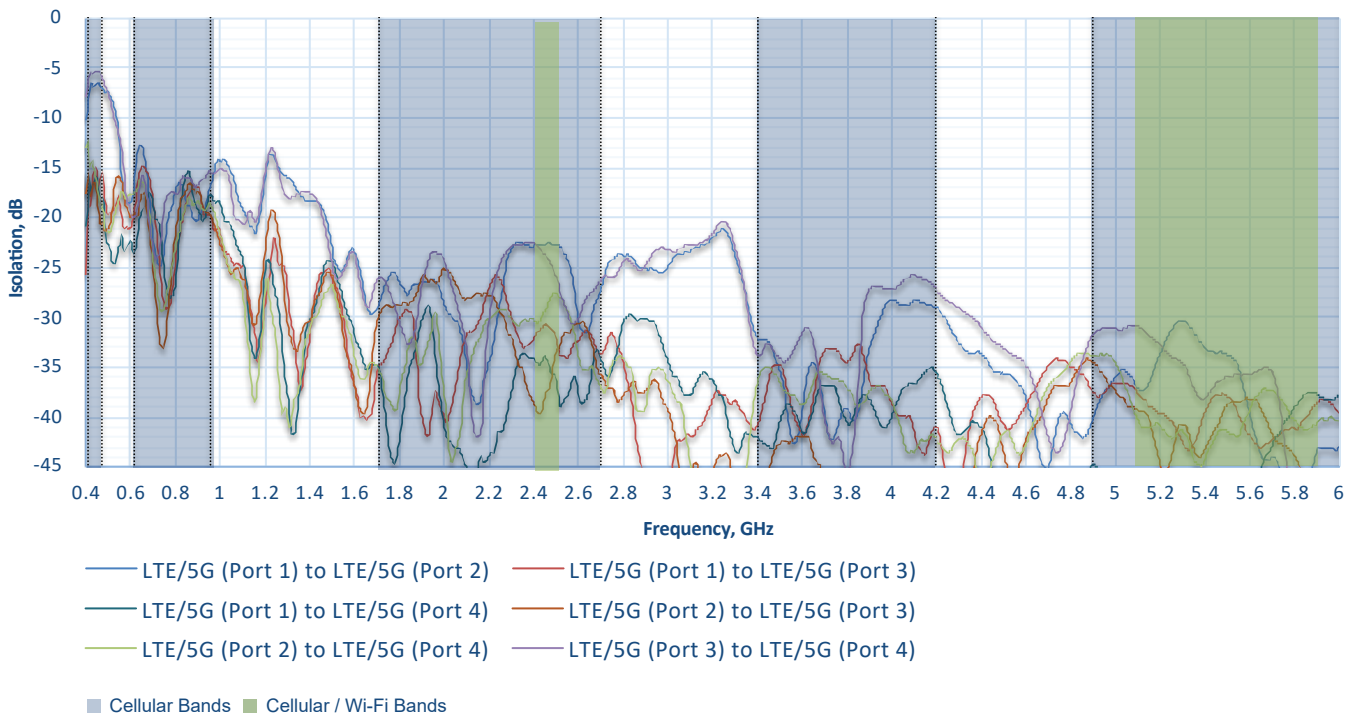

Cellular Antenna Gain

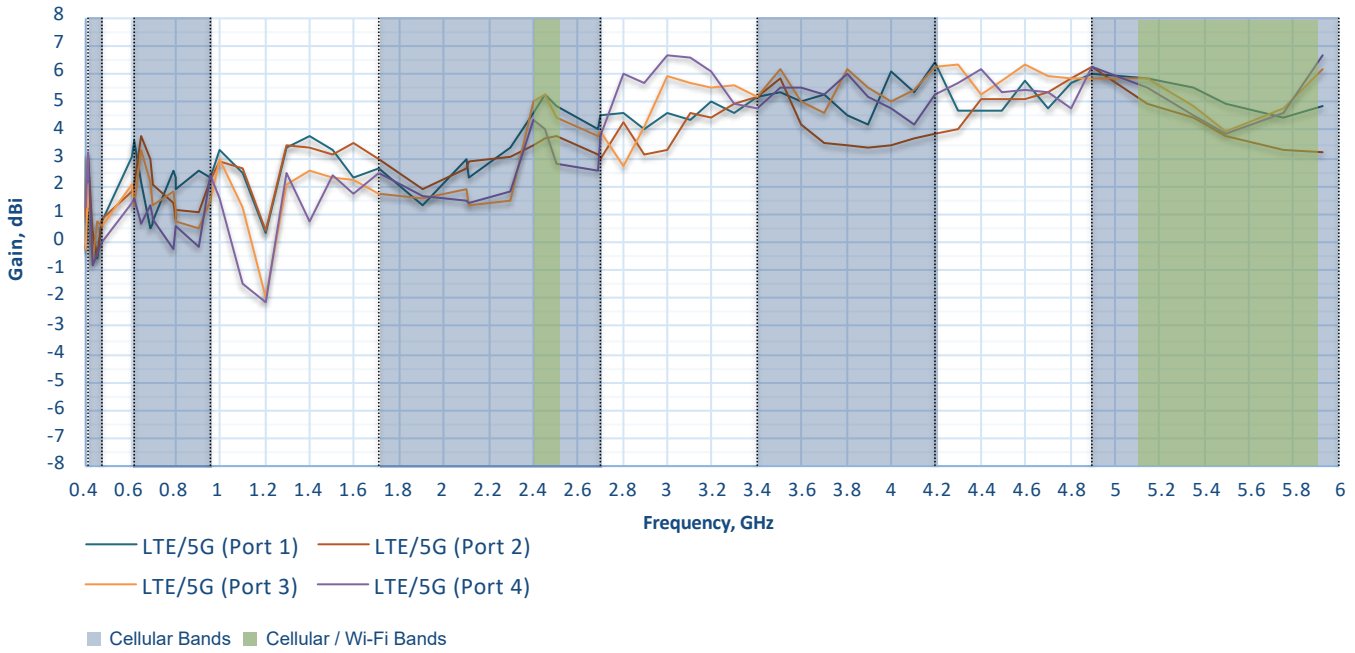

Cellular Antenna Efficiency

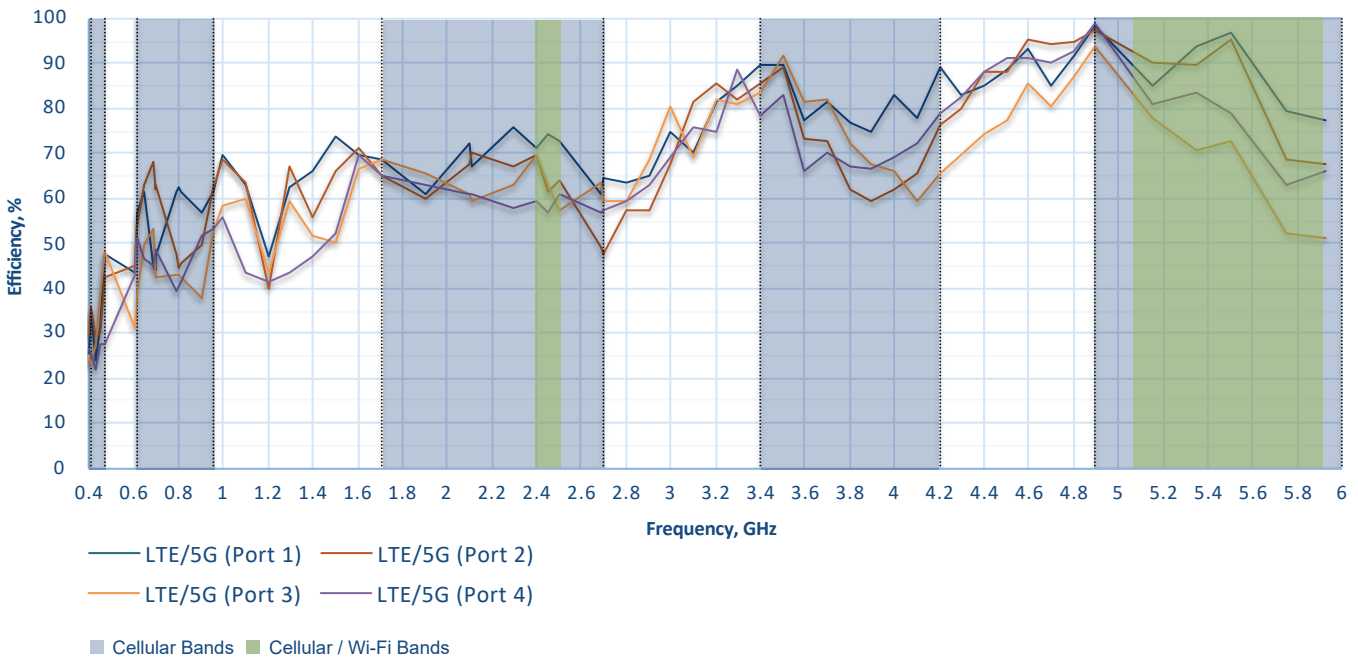

Maritime 40G

Radiation Patterns (Azimuth)

430-960 MHz

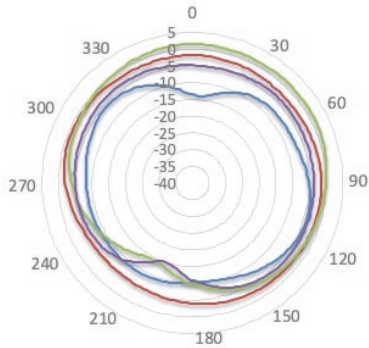

— 430MHz — 617MHz — 800MHz — 960MHz

1710-2100 MHz

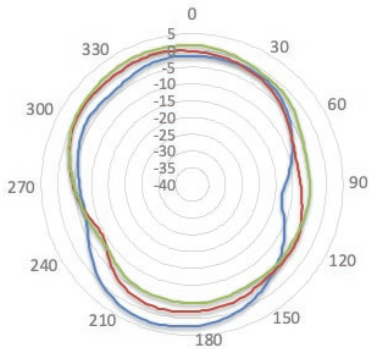

— 1710MHz — 1900MHz — 2100MHz

2300-2700 MHz

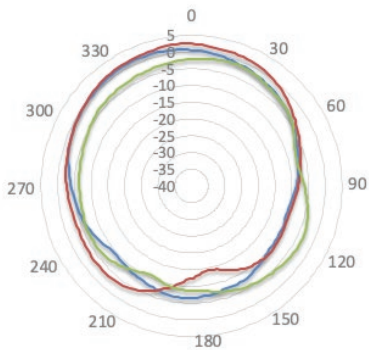

— 2300MHz — 2500MHz — 2700MHz

3400-3800 MHz

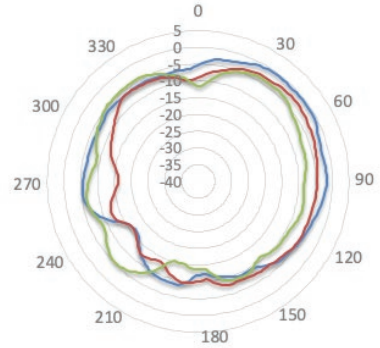

— 3400MHz — 3600MHz — 3800MHz

4200-5150 MHz

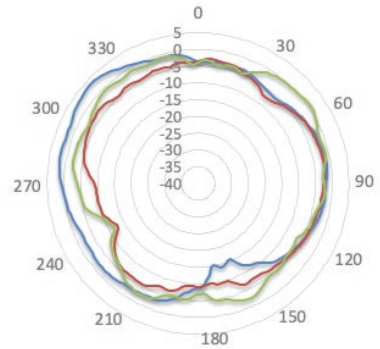

— 4200MHz — 4900MHz — 5150MHz

5350-5930 MHz

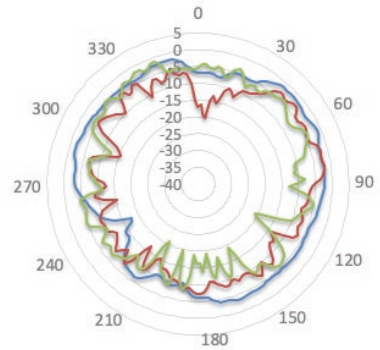

— 5350MHz — 5750MHz — 5930MHz

Maritime 40G

Radiation Patterns (Elevation 1)

430-960 MHz

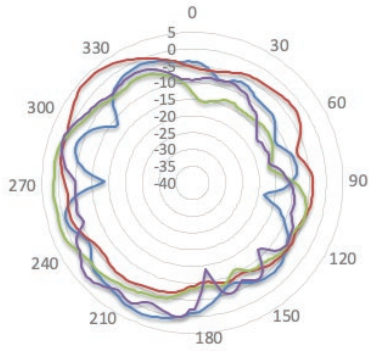

— 430MHz — 617MHz — 800MHz — 960MHz

3400-3800 MHz

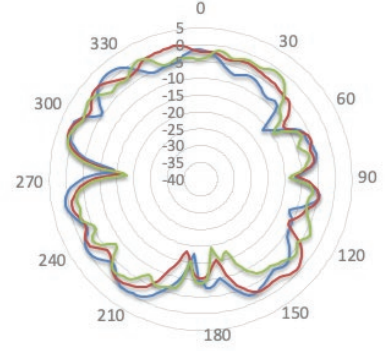

— 3400MHz — 3600MHz — 3800MHz

1710-2100 MHz

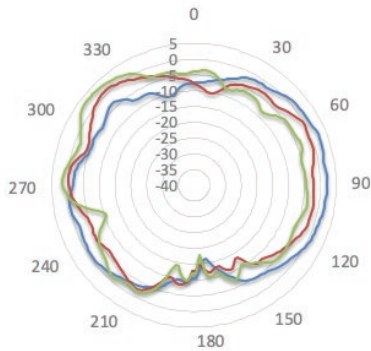

— 1710MHz — 1900MHz — 2100MHz

4200-5150 MHz

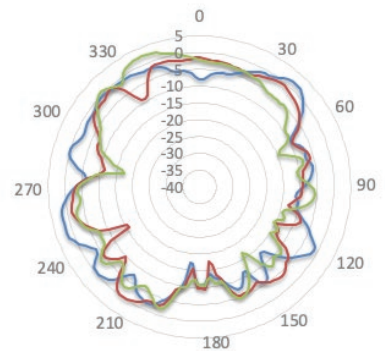

— 4200MHz — 4900MHz — 5150MHz

2300-2700 MHz

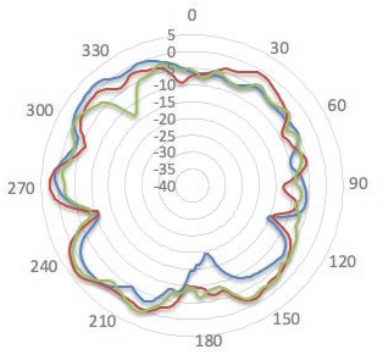

— 2300MHz — 2500MHz — 2700MHz

5350-5930 MHz

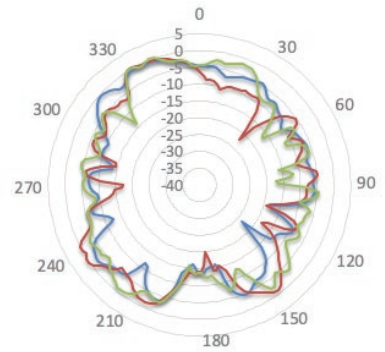

— 5350MHz — 5750MHz — 5930MHz

Maritime 40G

Radiation Patterns (Elevation 2)

430-960 MHz

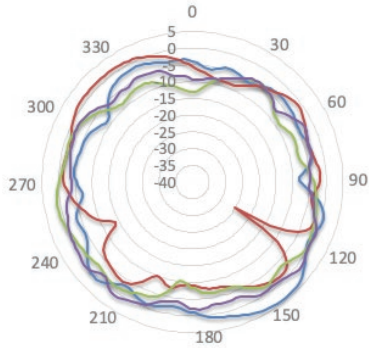

— 430MHz — 617MHz — 800MHz — 960MHz

3400-3800 MHz

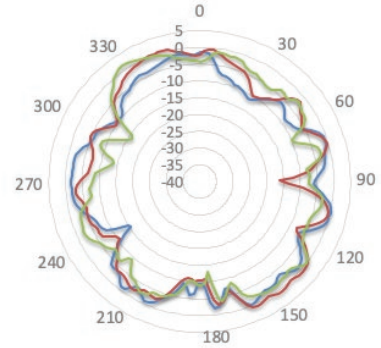

— 3400MHz — 3600MHz — 3800MHz

1710-2100 MHz

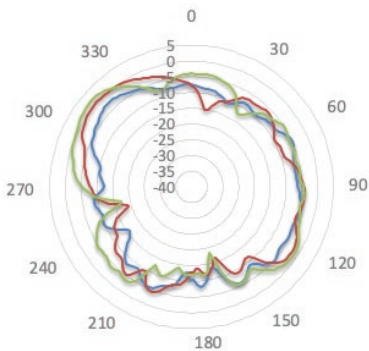

— 1710MHz — 1900MHz — 2100MHz

4200-5150 MHz

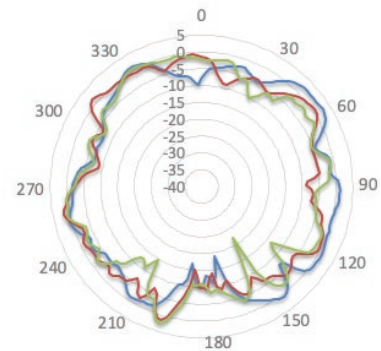

— 4200MHz — 4900MHz — 5150MHz

2300-2700 MHz

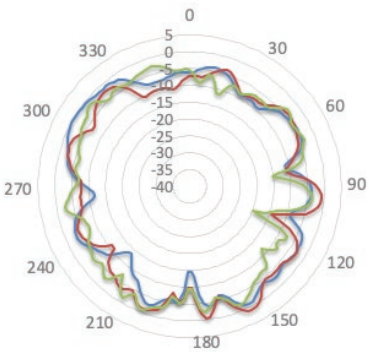

— 2300MHz — 2500MHz — 2700MHz

5350-5930 MHz

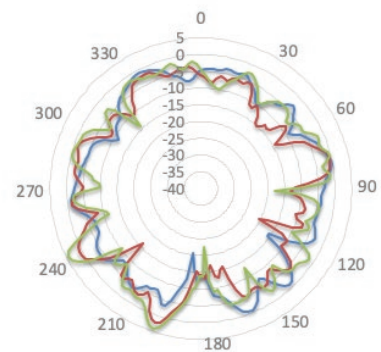

— 5350MHz — 5750MHz — 5930MHz

Maritime 40G

Installation Recommendation

Maritime Mount (cable inside)

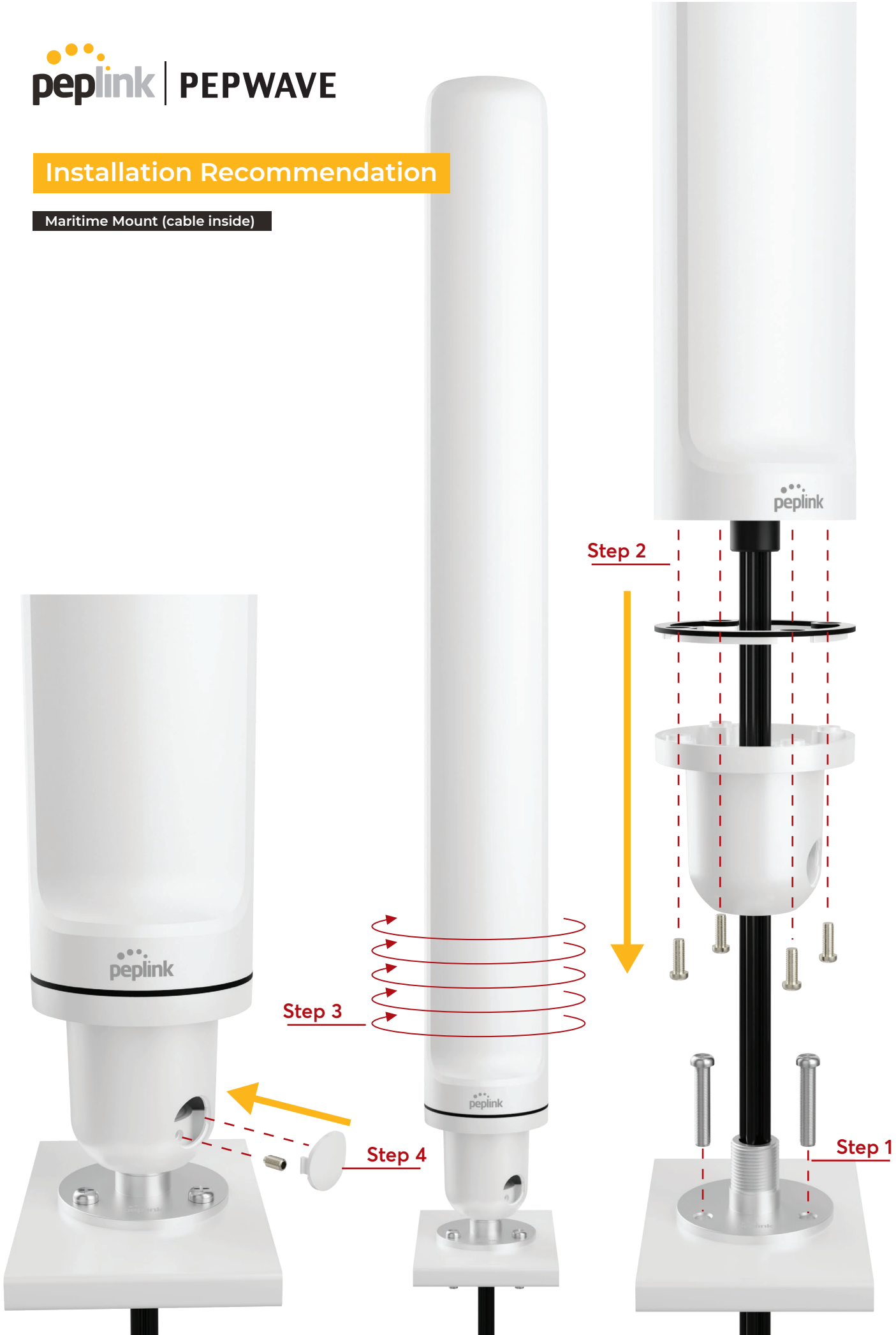

Maritime 40G

Installation Recommendation

Maritime Mount (cable outside)

Maritime 40G

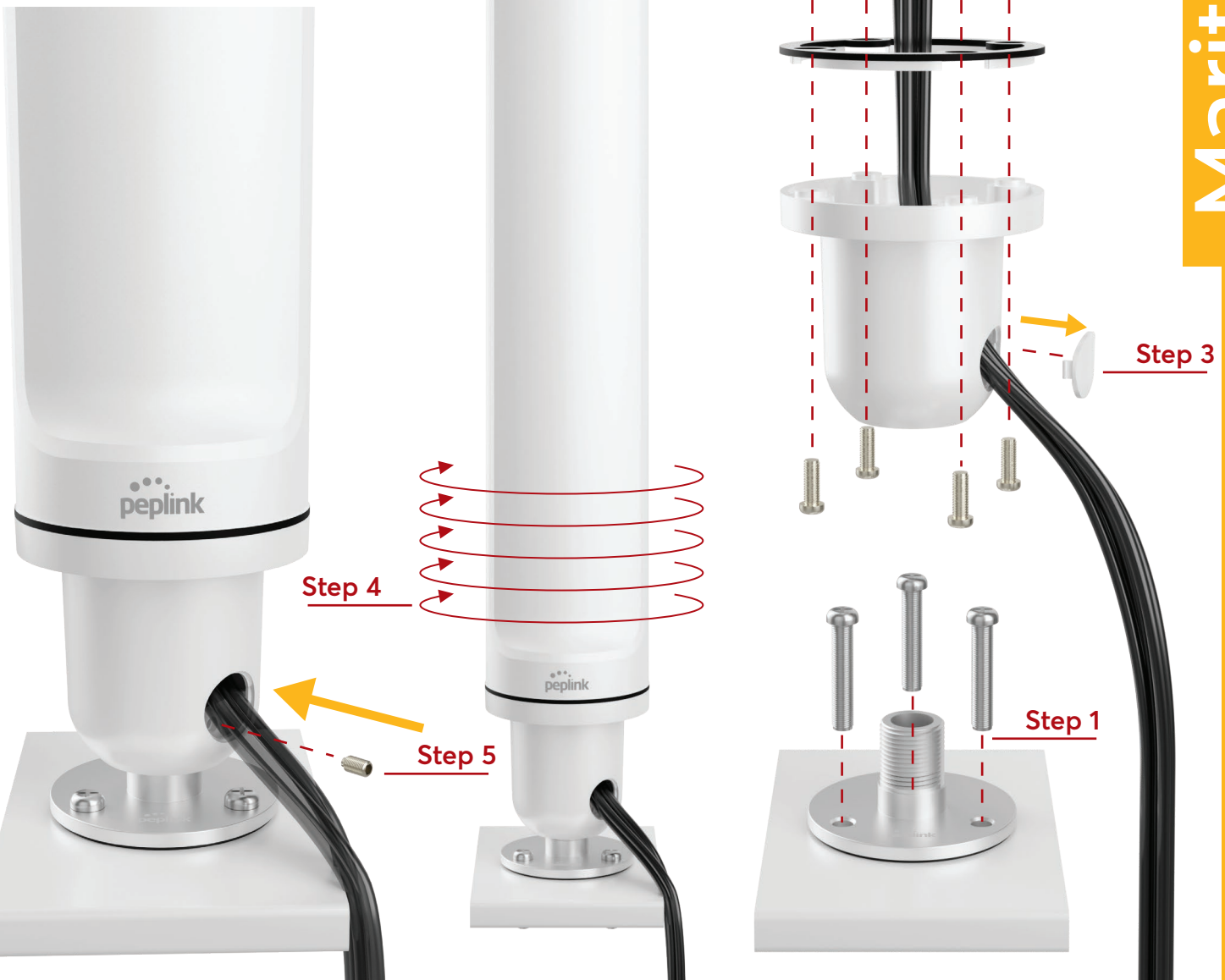

Installation Recommendation

L-shape Mount (horizontal pole)

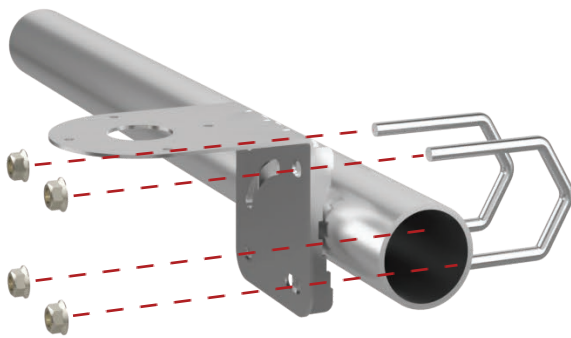

Maritime 40G

Installation Recommendation

L-shape Mount (vertical pole)

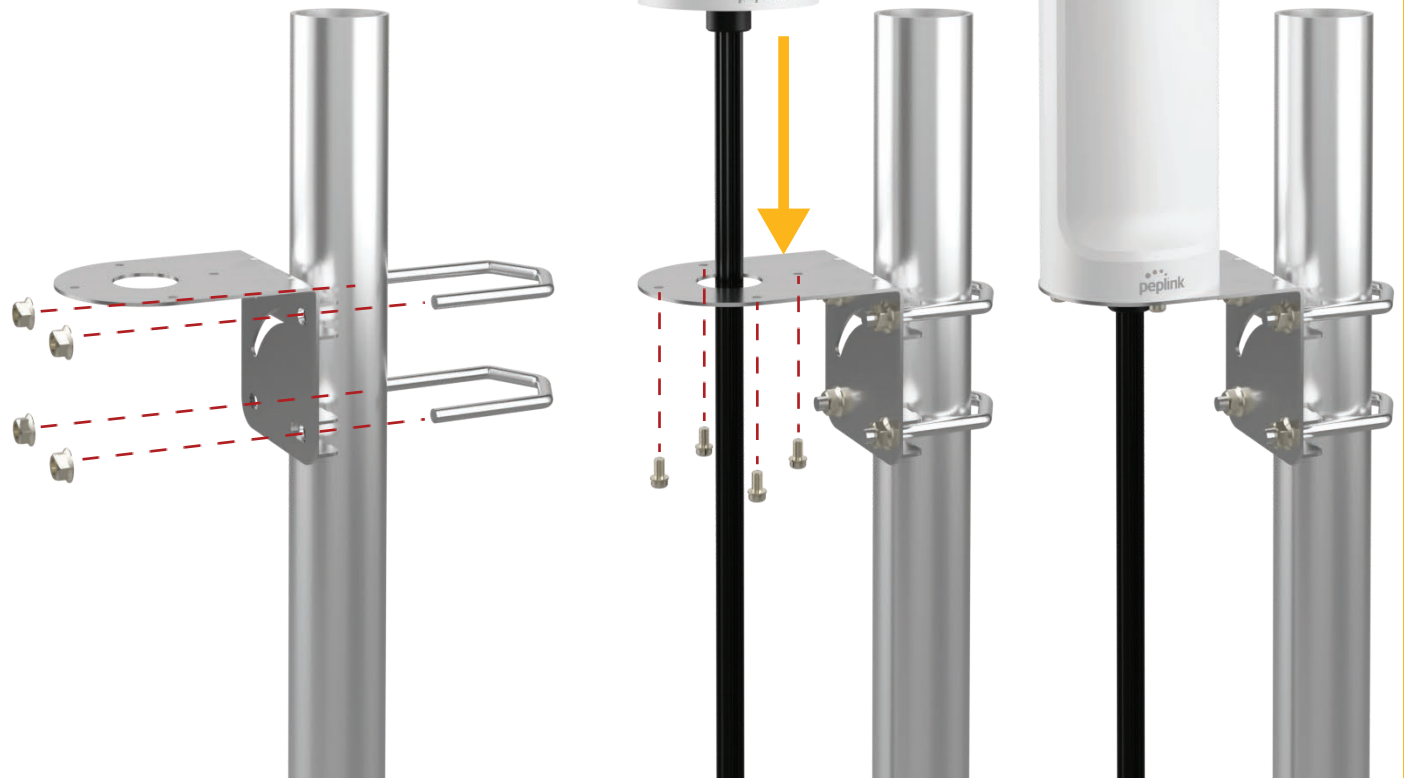

Maritime 40G

Packing List Information

Antenna

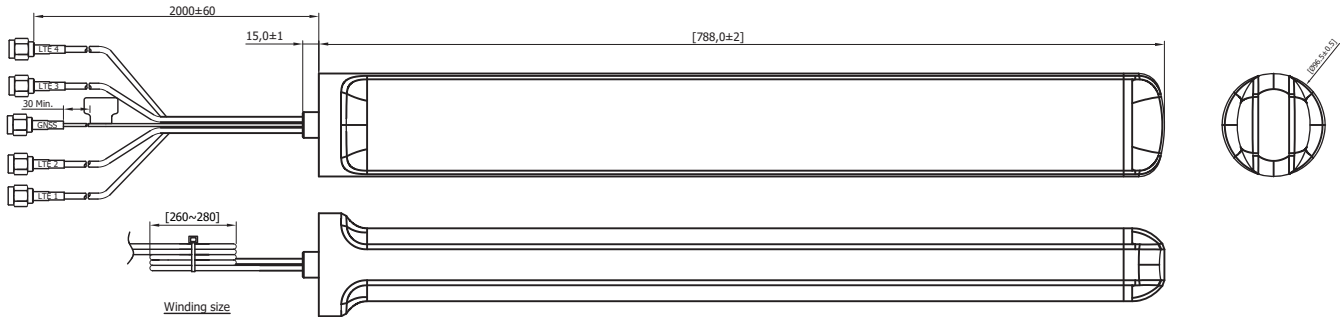

Maritime Mount Set

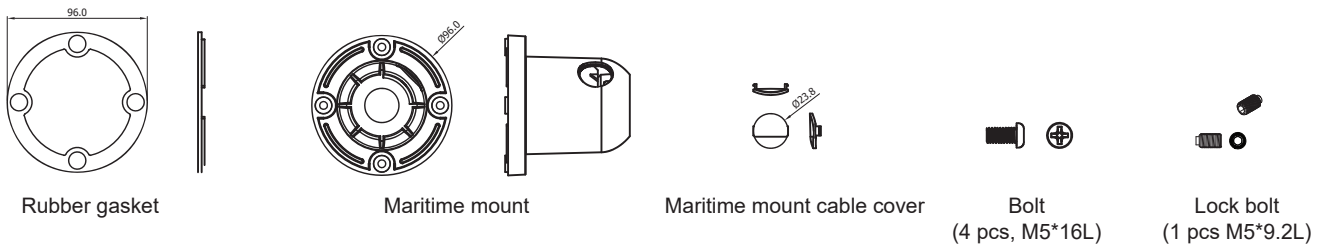

Deck Mount Set

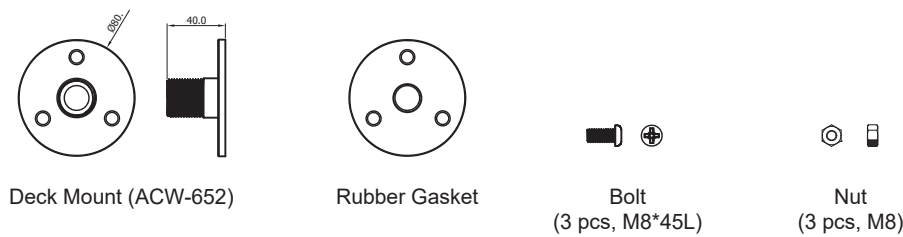

L-Mount Mount Set

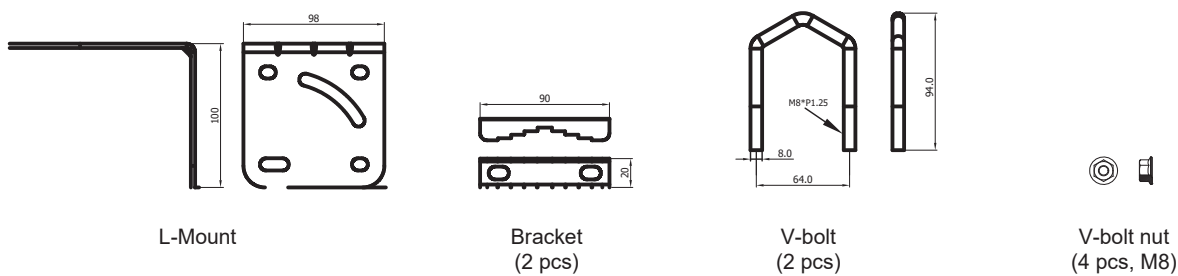

Maritime 40G